

场地分析

Site Analysis

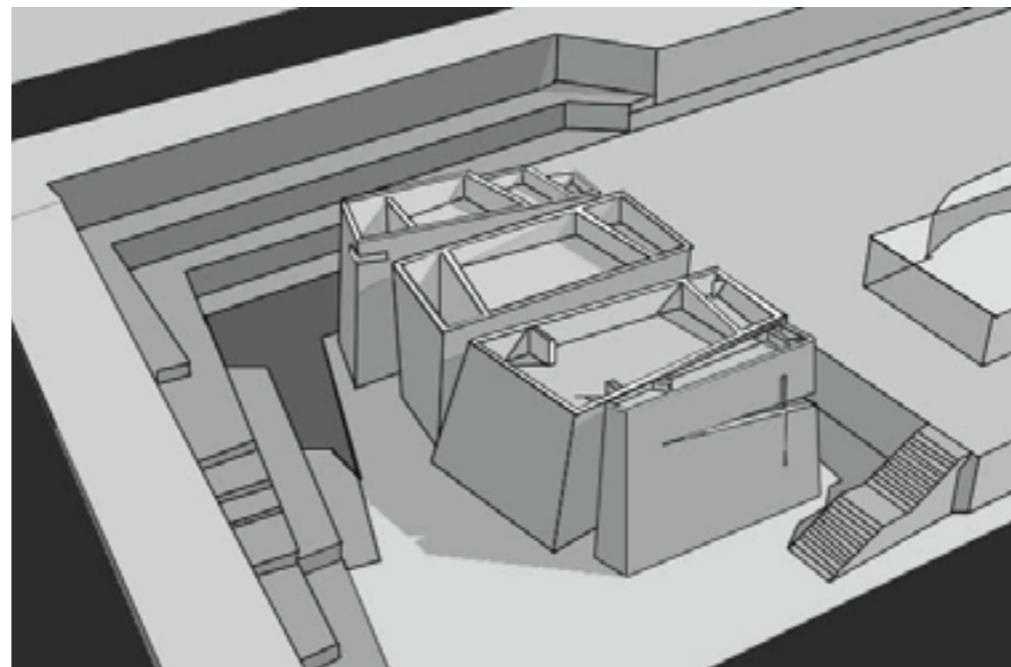

功能分区

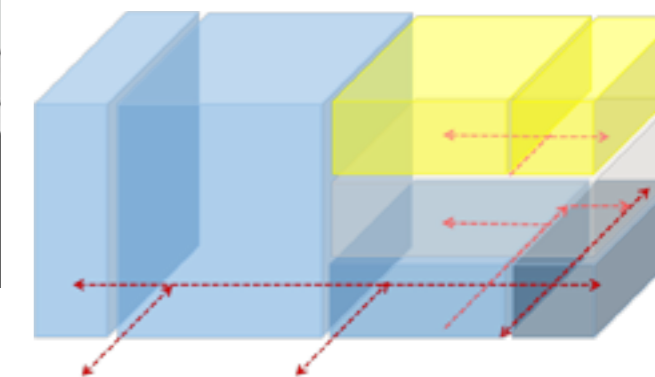

水平交通



垂直交通

体块分析

Space Analysis

# Church in La Laguna

Basic Information:

Architect: Fernando Menis

Location: Tenerife, Spain

Completed time: 2008

王吉辰 戴凌澜

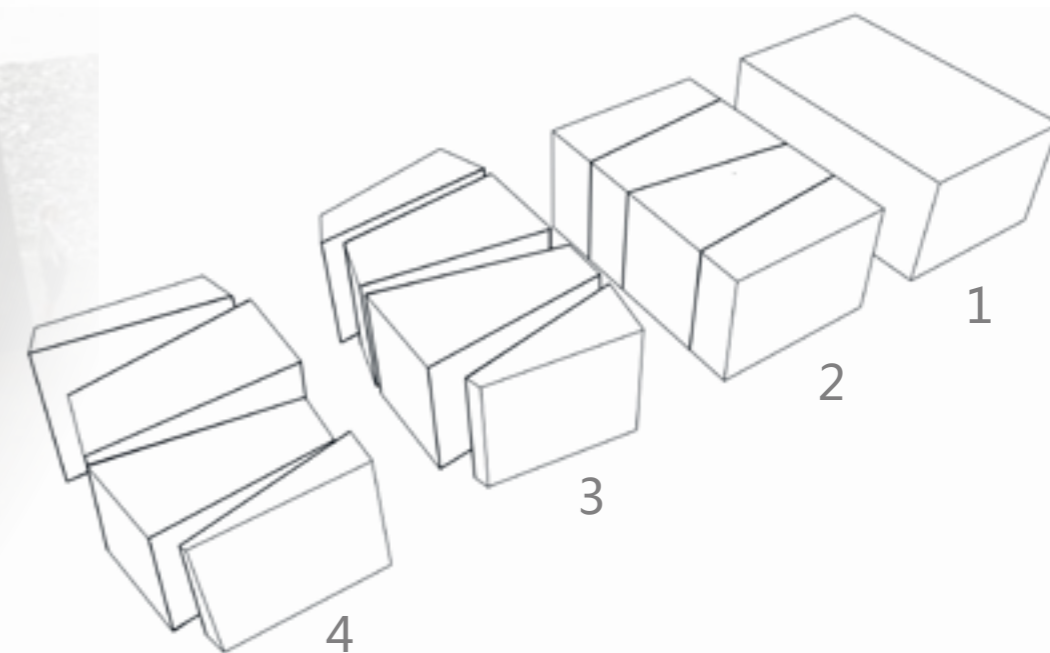



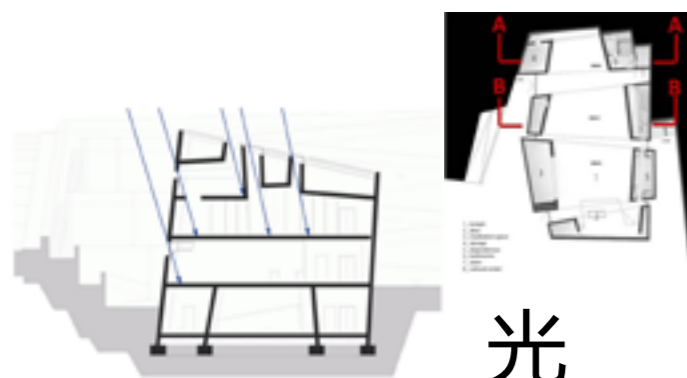

A-A 剖面夏至

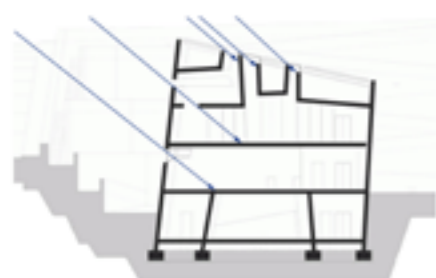

A-A 剖面冬至



B-B 剖面夏至

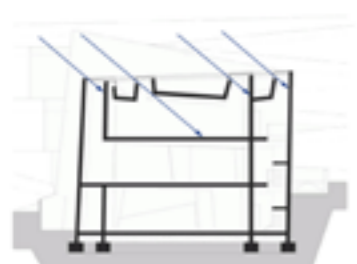

B-B 剖面冬至

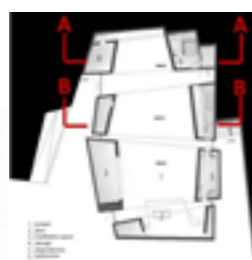

# 光照分析

Light Analysis



0 floor



1 floor



2 floor

# 围合关系

Enclosure

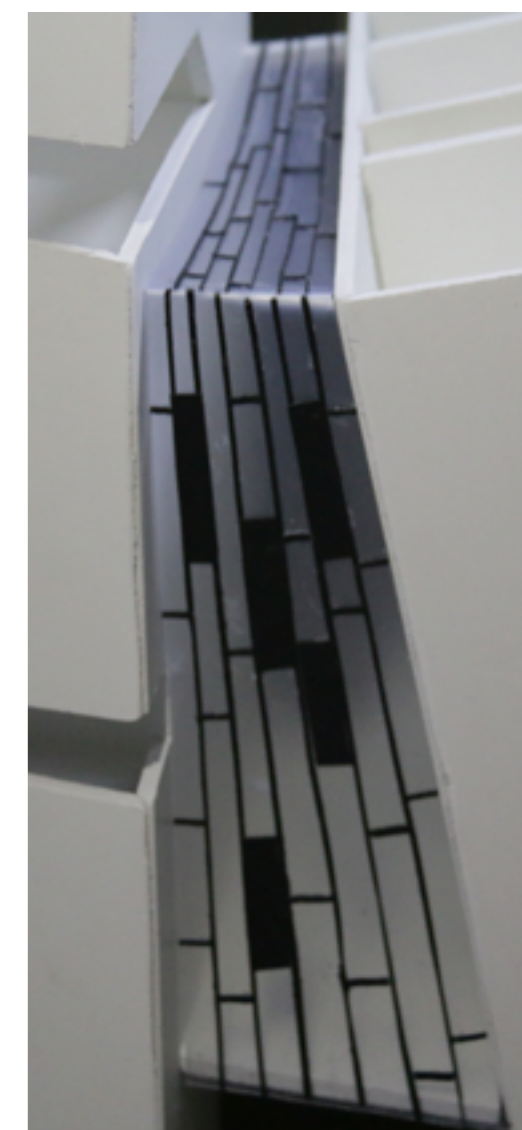

天井光效模型



A-A 剖面光效



B-B 剖面光效



C-C 剖面光效