

# Seoul National University Of Art

首尔国立大学博物馆

----by Rem Koolhaas

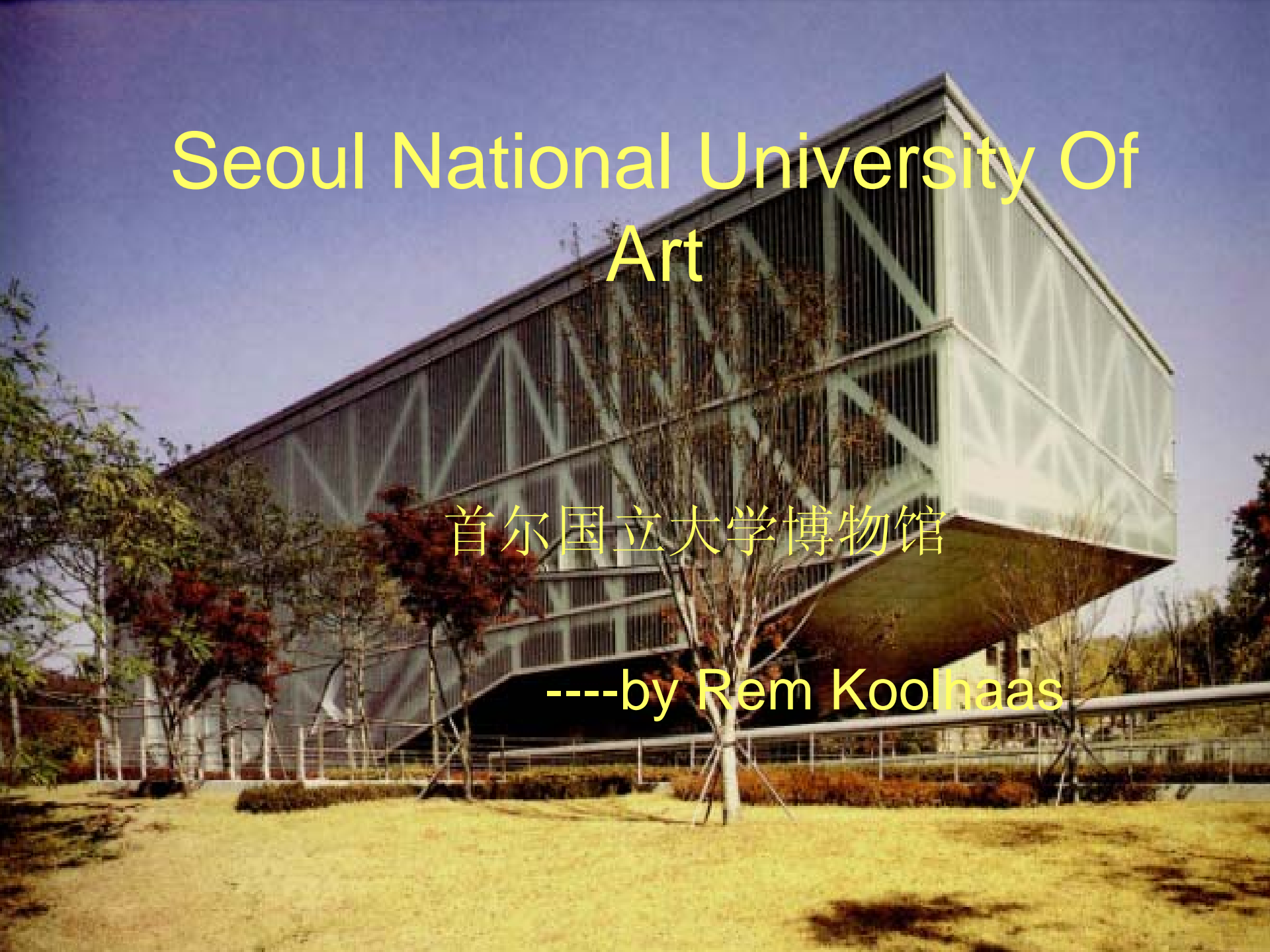

# 体量关系

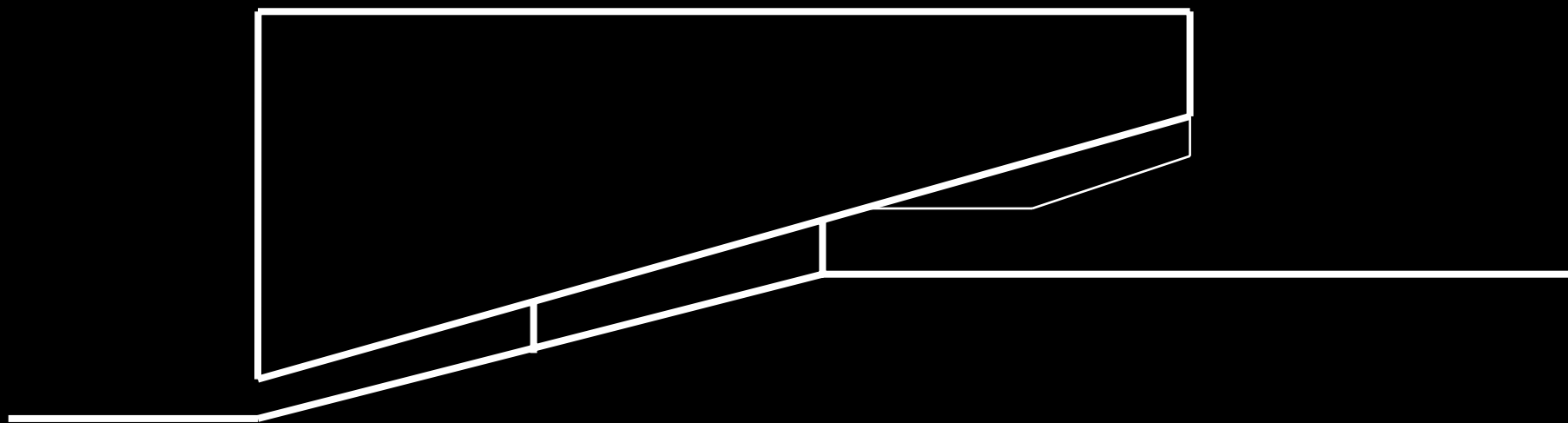

# 结构（混凝土，钢悬臂）

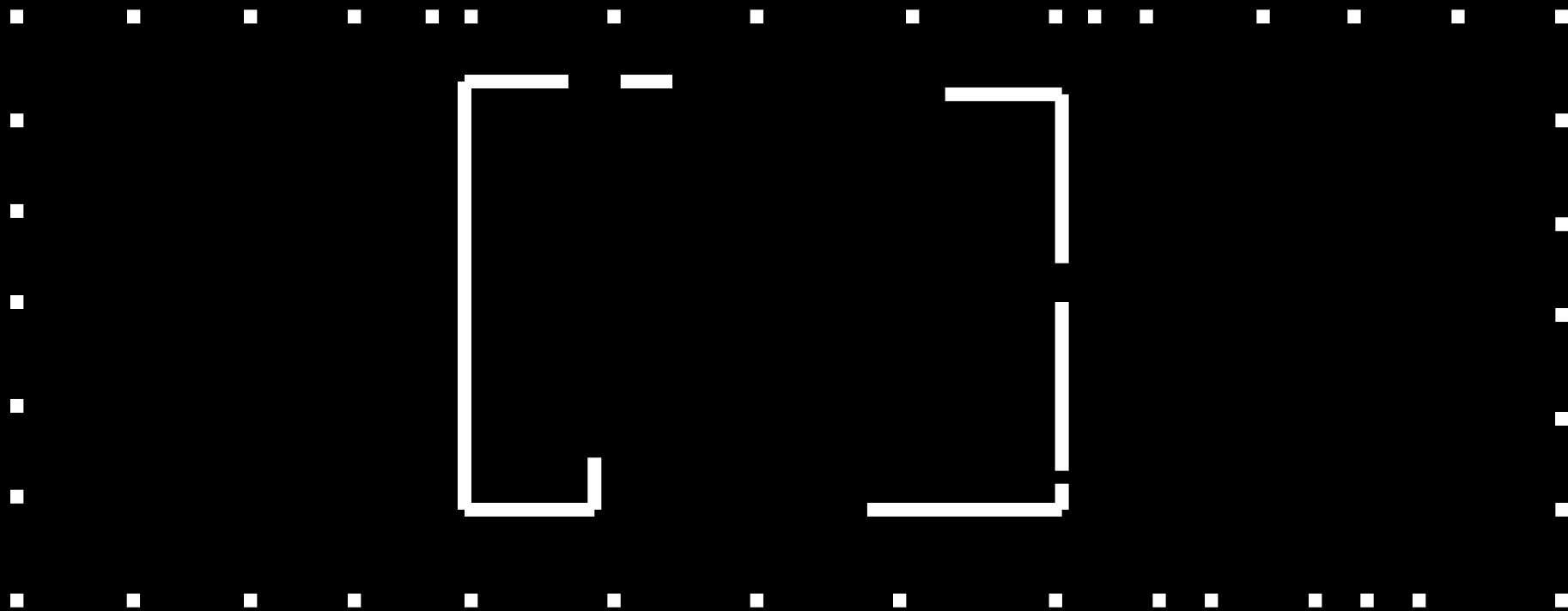

# 重复到独特

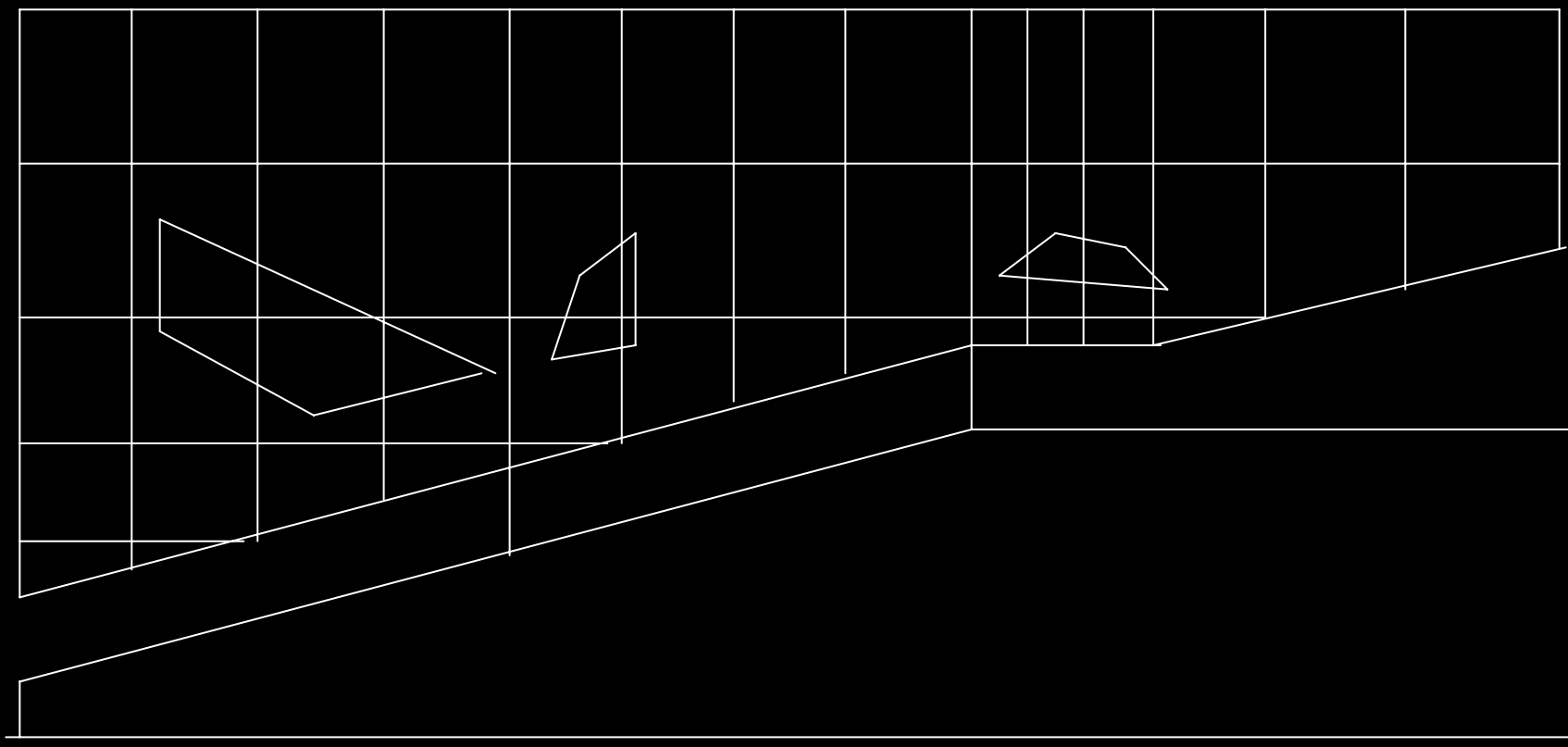

# 对称和均衡

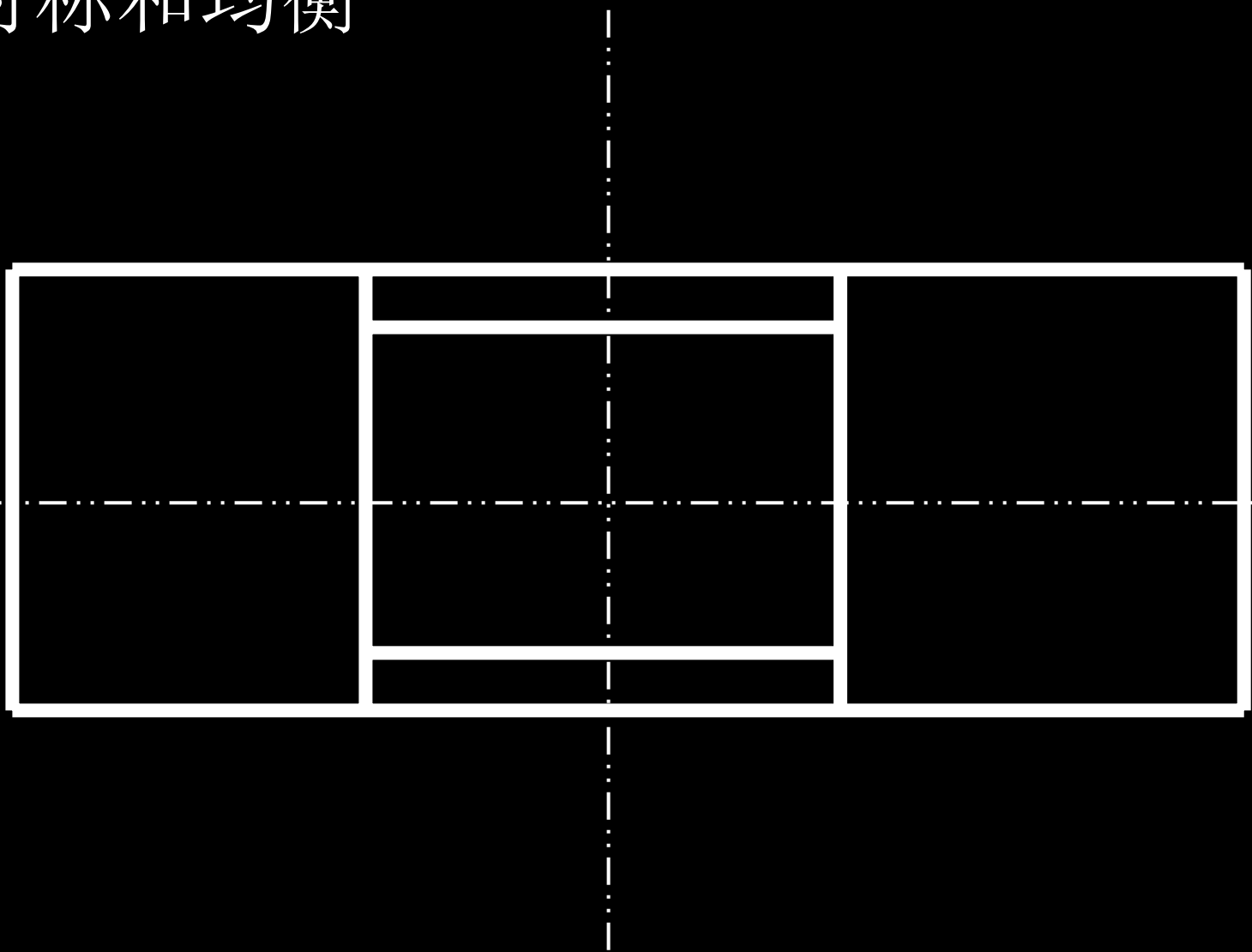

# 加法和減法

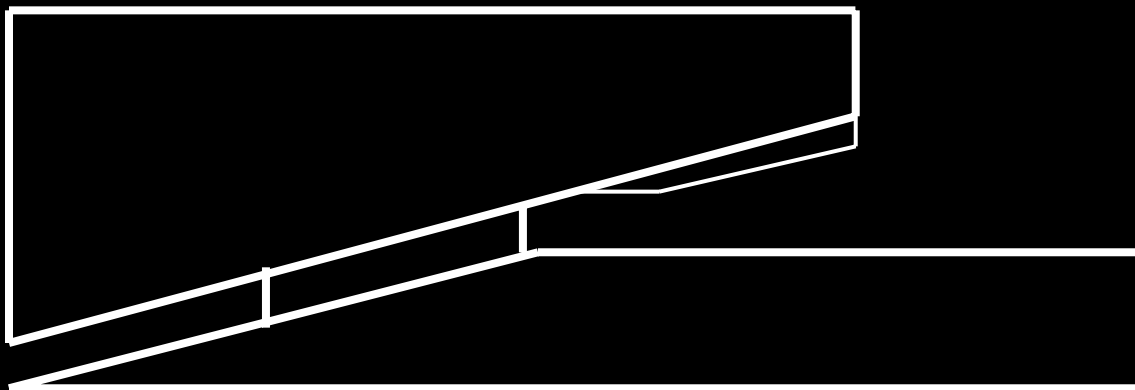
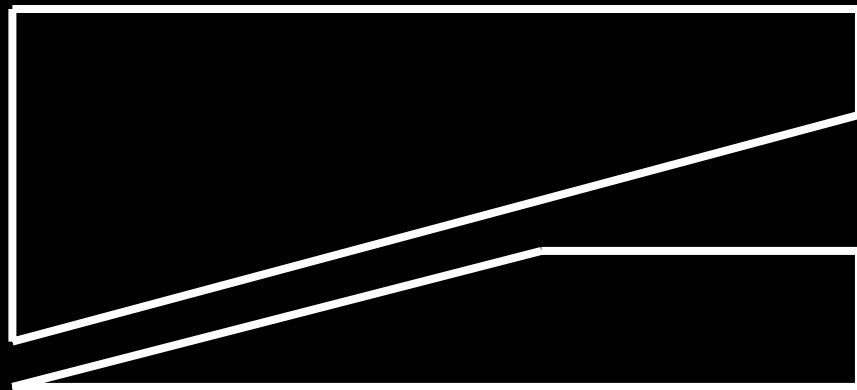

# 交通流线



# 交通流线

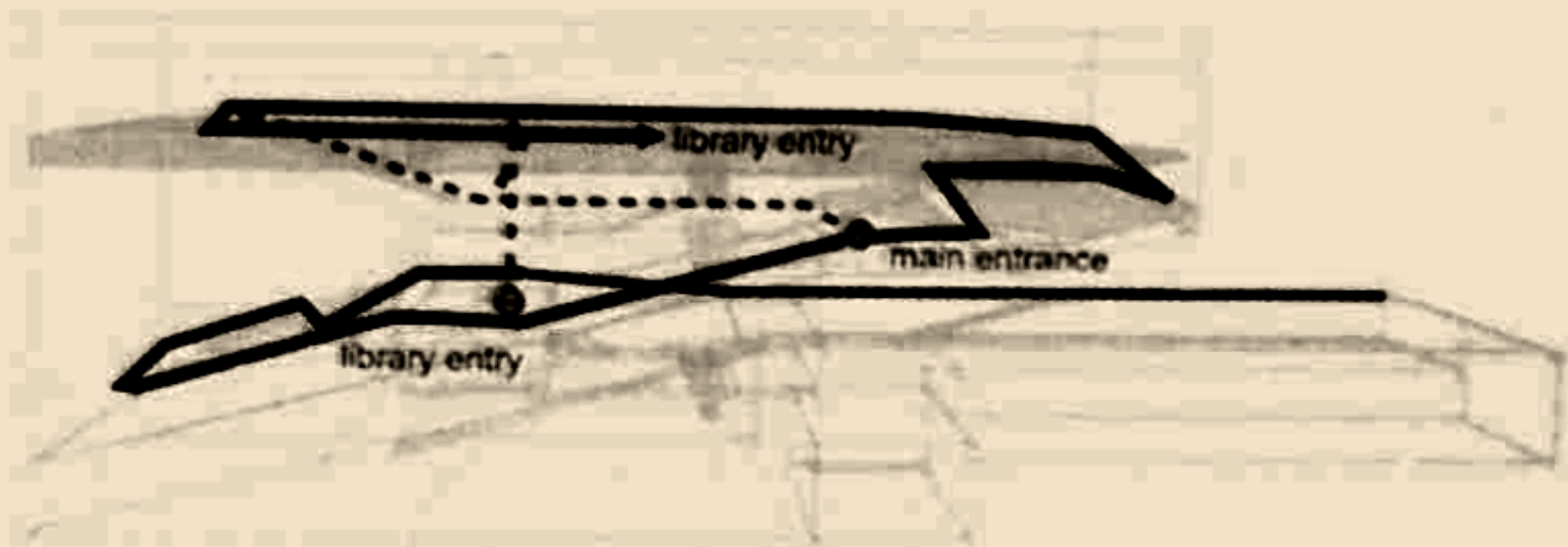



# 交通流线

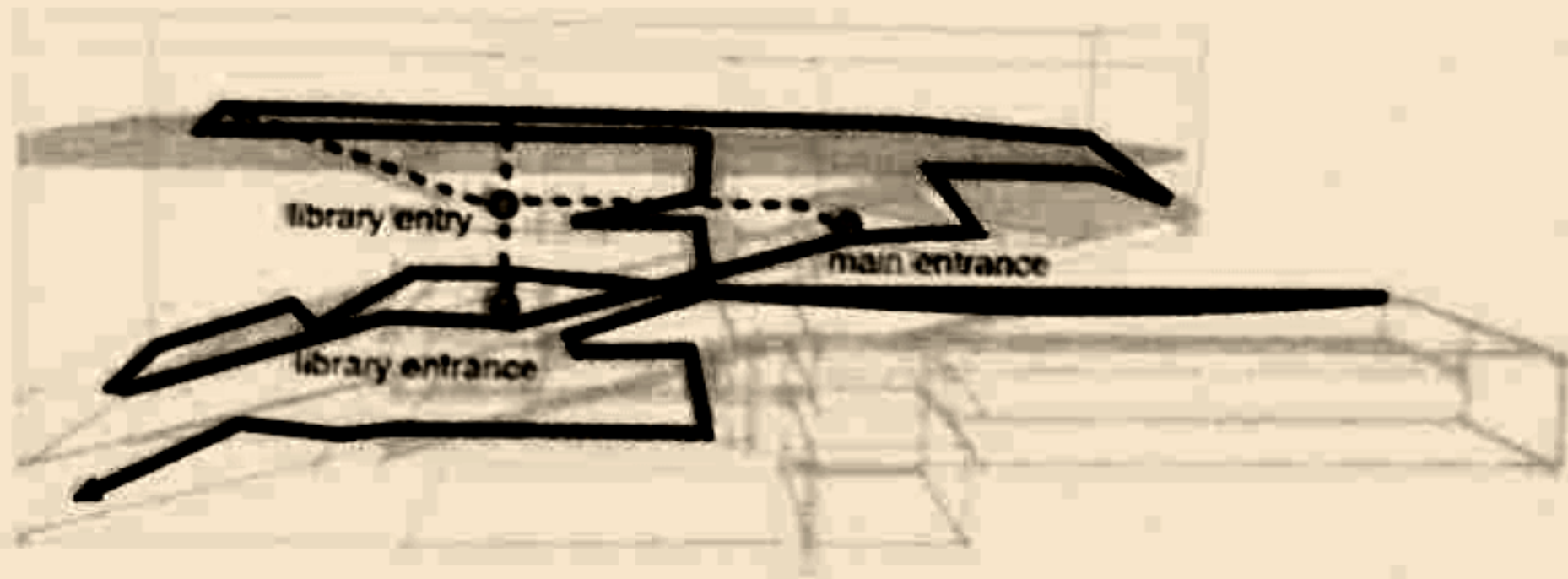

# 使用空间

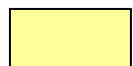
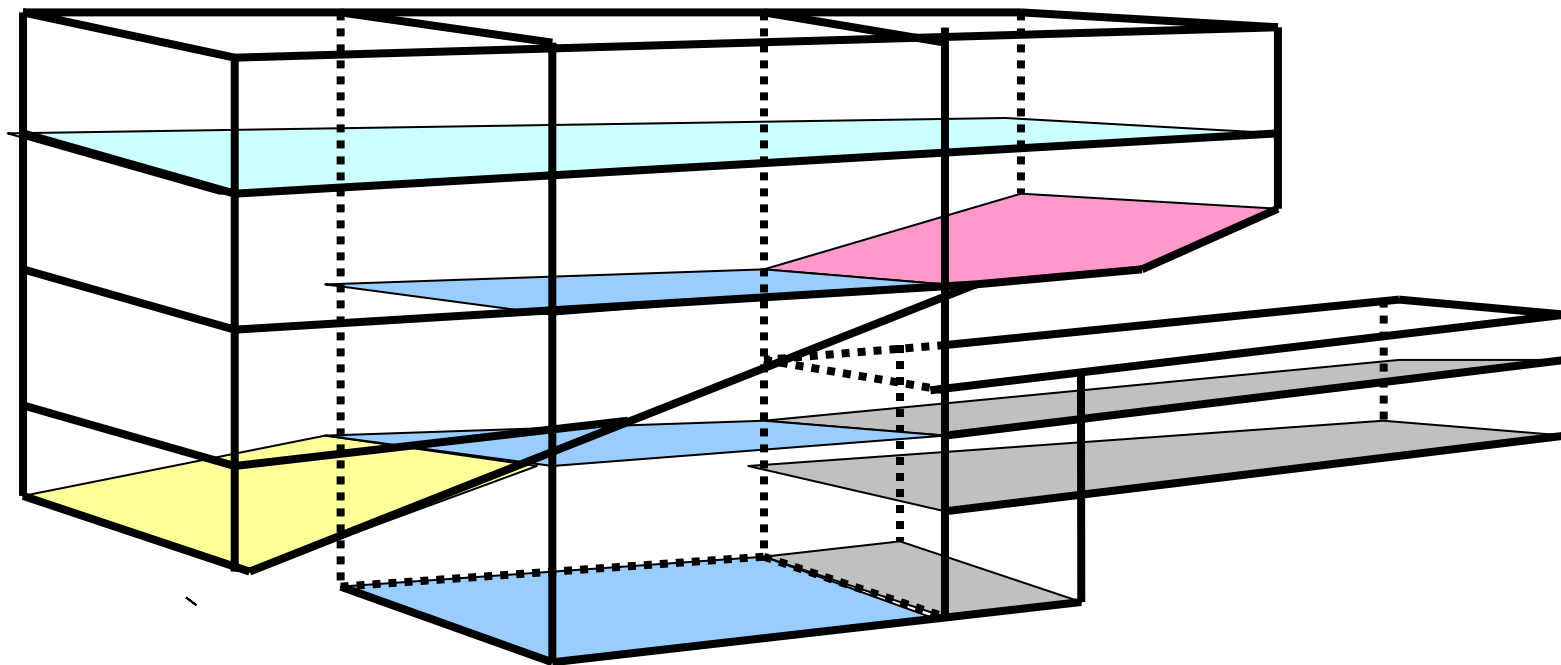

大礼堂



图书馆



工作室

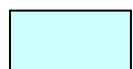

展览馆



演讲厅

# 等级关系

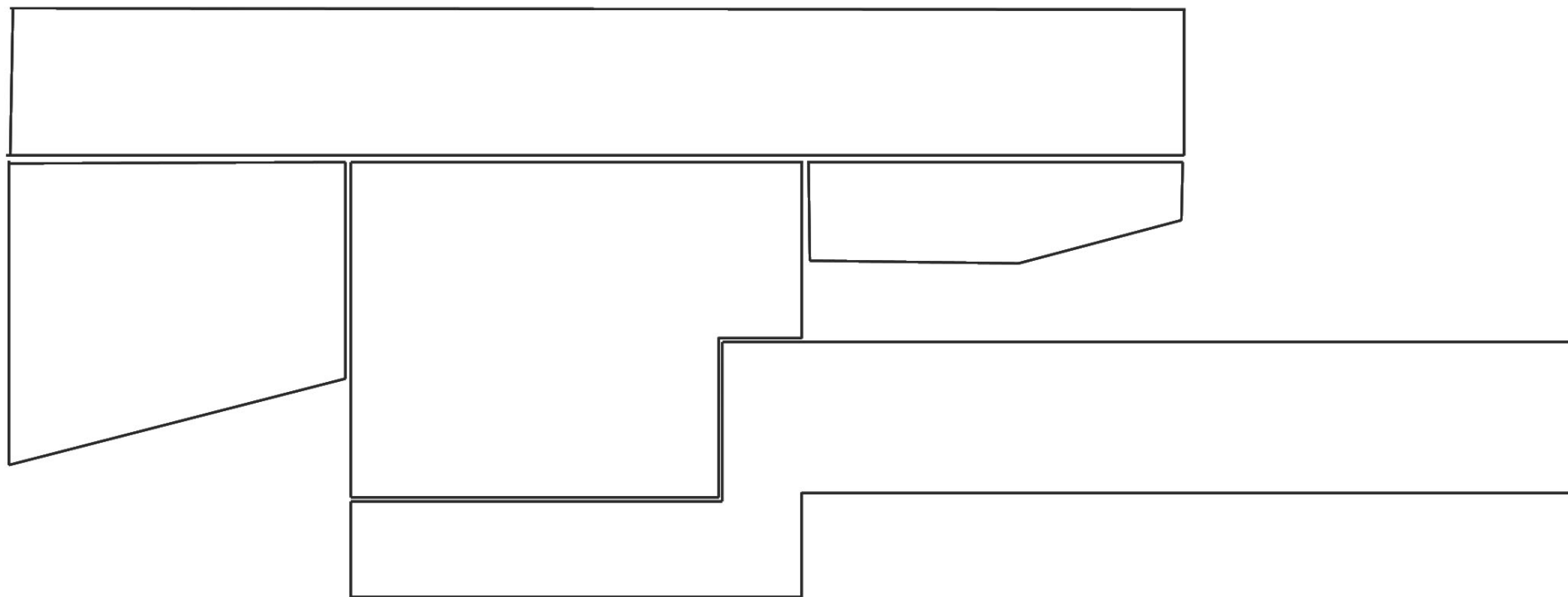

几何关系 (1:1的长方形)

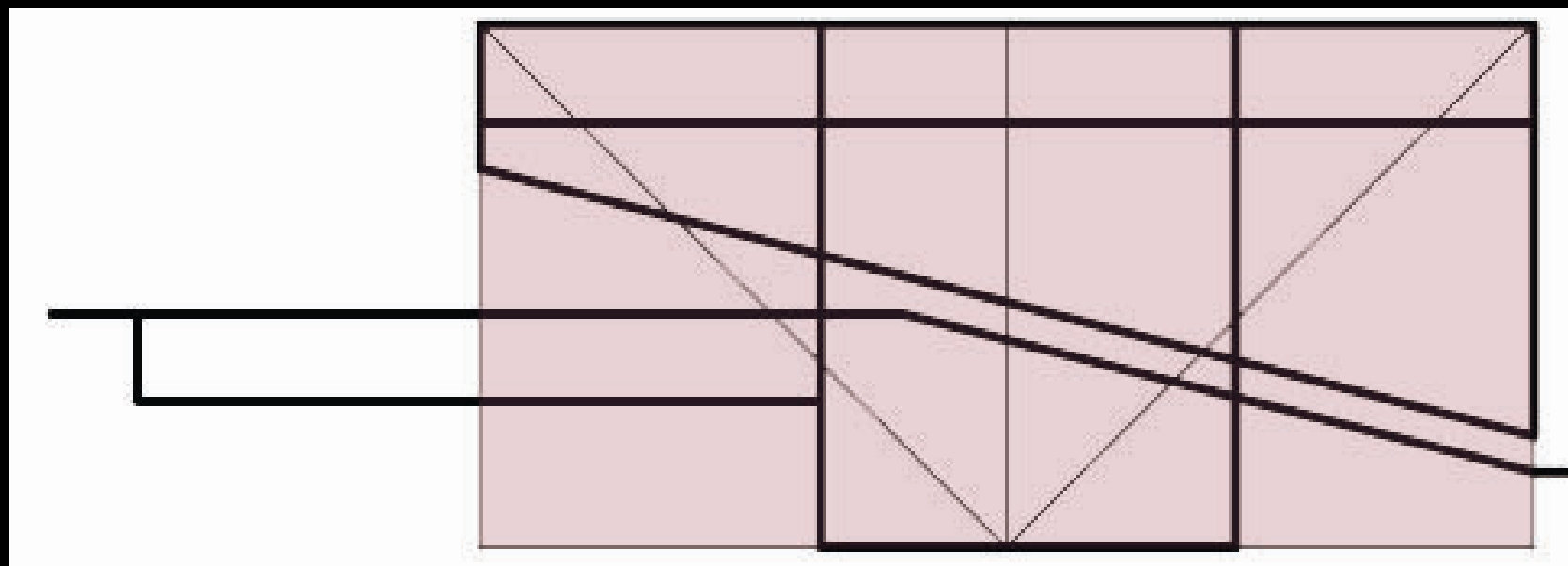
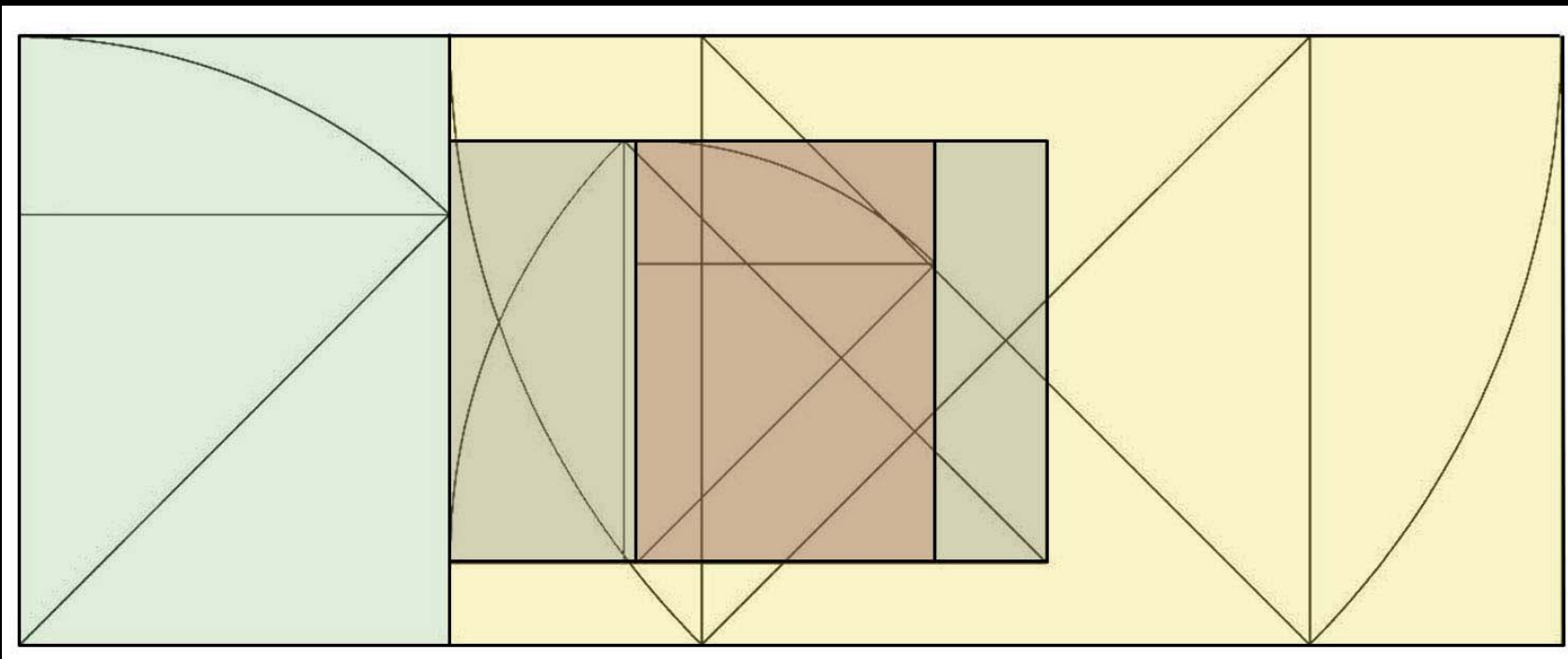

# 自然光

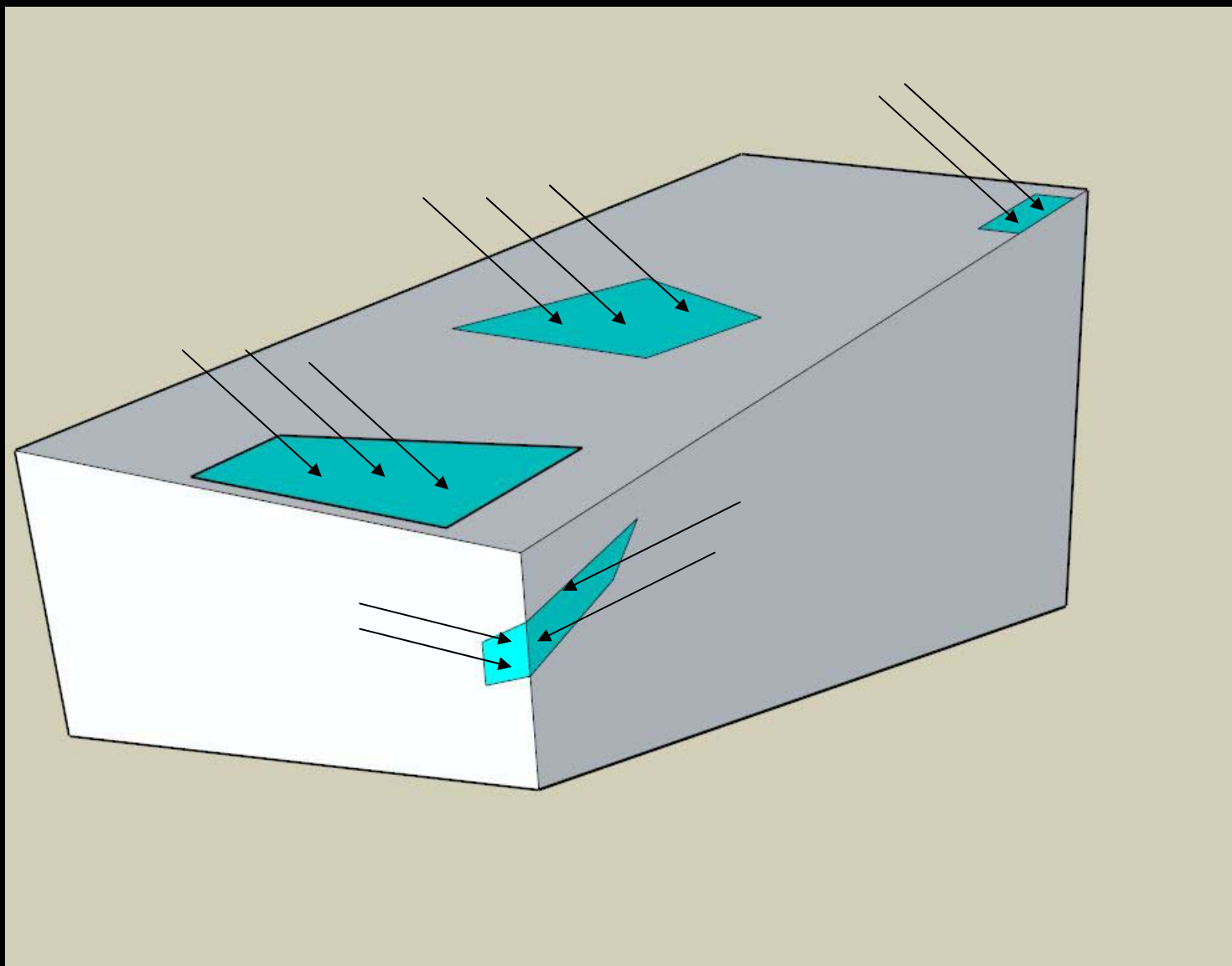

# 自然光

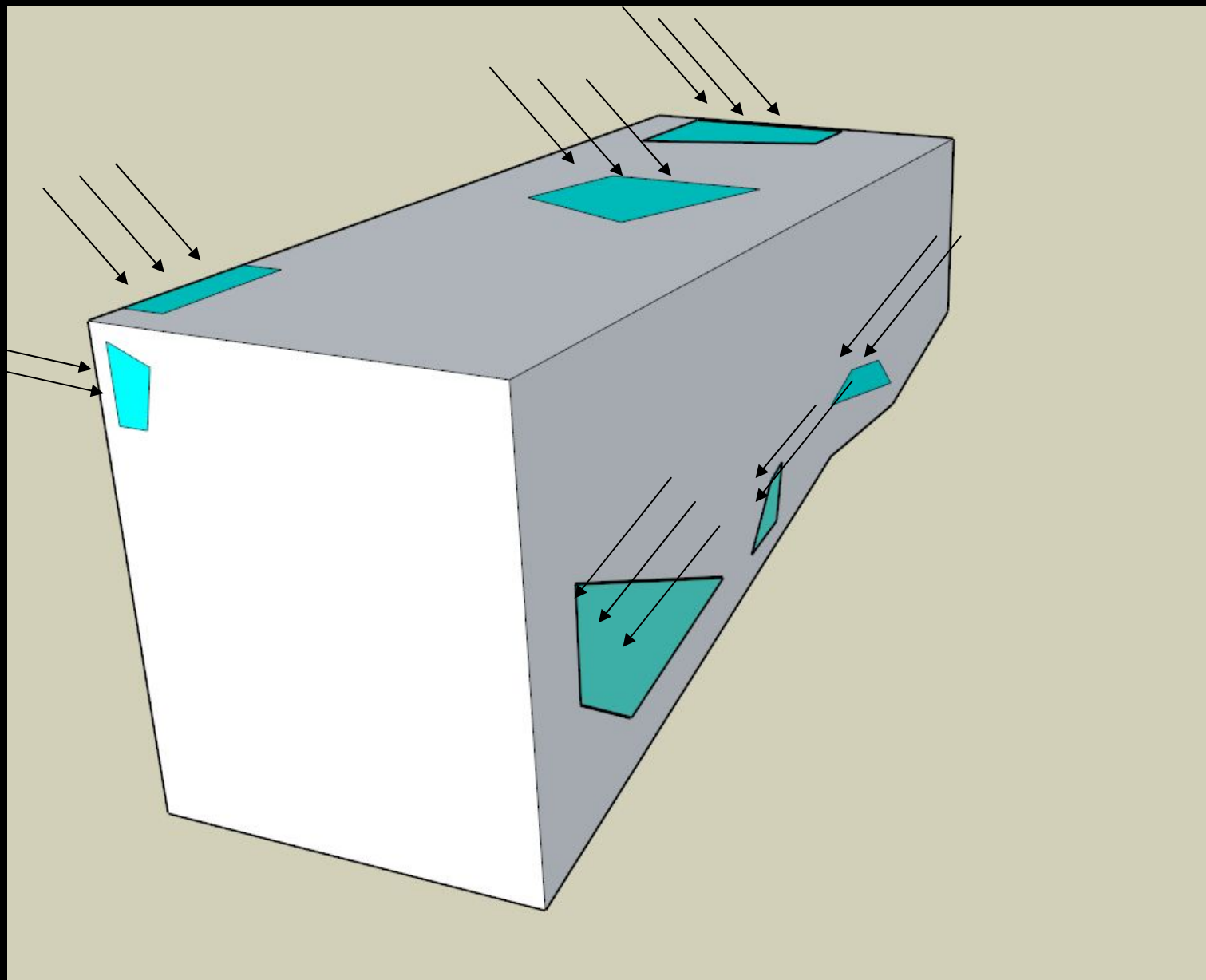











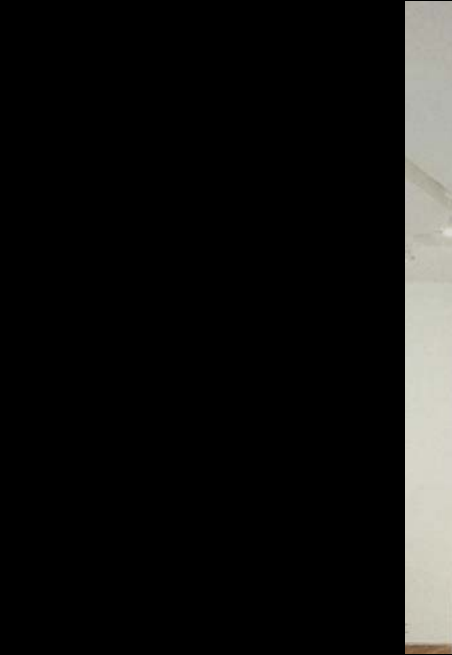









# The End

5080159055 吴晨昊

5080159044 陈开宇